

**Integrated Illumination Systems, Inc.**  
 355 Bantam Lake Road  
 Morris, CT 06763 USA

tel +1.860.567.0708  
 fax +1.860.567.2501

support@i2Systems.com  
 www.i2Systems.com

# i2Cove

# i2Systems®

ADVANCED LED LIGHTING

## Asymmetrical Installation Instructions

Before you begin, read these instructions completely and carefully. If you have any questions regarding the proper use, installation, or safety considerations of this product, please visit our website or contact i2Systems Customer Support @ 860.567.0708.

**DANGER: RISK OF ELECTRICAL SHOCK OR FIRE. DISCONNECT POWER BEFORE INSTALLATION.**

**WARNING:** Risk of fire or electric shock. Installation of LED fixture requires knowledge of electrical systems. If not qualified, do not attempt installation. Contact qualified electrician.

This luminaire must be installed in accordance to your local electrical code. If you are not familiar with these codes and requirements, consult a qualified electrician.

### Electrical Specifications

PARAMETER	VALUE
Input Power	8 Watts* / Ft
Input Voltage	120-277V AC, 50/60 Hz
Max. Fixture Run Length	8 Watts: 120VAC: 60 Ft 208VAC: 100 Ft 240VAC: 100 Ft 277VAC: 100 Ft
LED Color (CCT)	2700 K, 3000 K, 3500 K
LED Color Consistency	2-Step MacAdam Ellipse
Temperature	Operating: -20°C to +40°C Startup: -20°C to +40°C Storage: -30°C to +60°C Relative Humidity: 10 - 90% Humidity: (non-condensing)
Driver	Integrated
Dimming	Between 10% and 100% via 0 - 10 VDC

\* Fully programmable. Other options available.

### Physical Specifications

PARAMETER	VALUE
Dimensions	Length: 12.13" [308 mm], 36.13" [918 mm] or 48.13" [1222 mm] Width: 3.2" [81 mm] Height: 1.6" [41 mm]
Housing Construction	Extruded Aluminum
Lens Construction	Polycarbonate
Beam Angle	120° Asymmetrical
Weight	1.45 lbs / Ft
Power Entry Cable	Allow 6" [152 mm] for bend radius
Mounting Options	Flat Brackets (standard) Adjustable Brackets (option) Corner Kit (option)
Environment	Indoor Use Only

### Components:

#### i2Cove Asymmetrical LED Light Fixtures

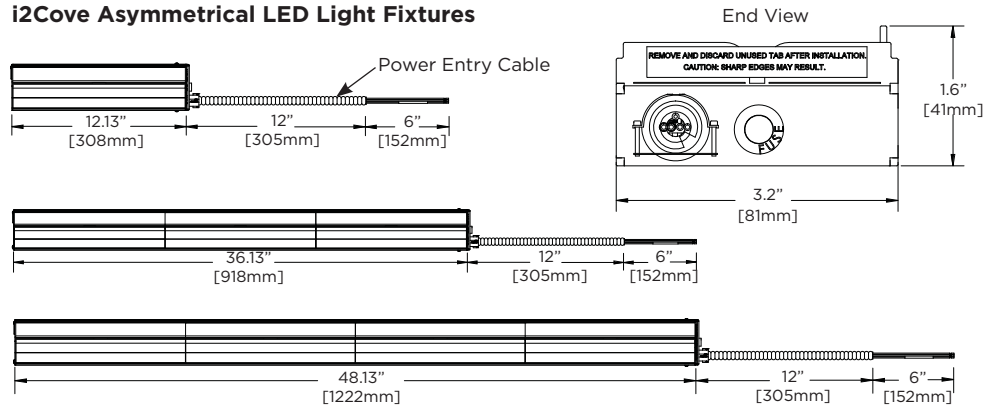

#### Flat Mounting Bracket CAB-1 (2 brackets supplied with each fixture)

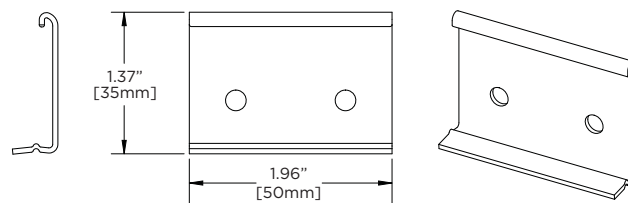

- For surface mounting fixtures
- Secure with mounting screws
- Snap fixture into place

### Options:

#### Adjustable Mounting Bracket CAB-2

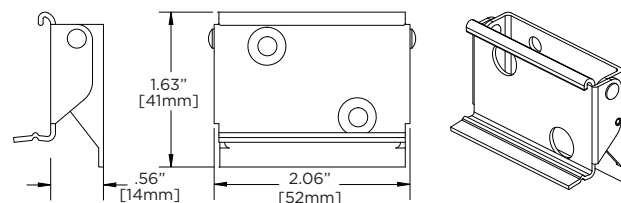

- For surface mounting fixtures
- Four angle positions
- Secure with mounting screws (not included)
- Snap fixture into place

#### Plug-In Corner Kit CAK-1

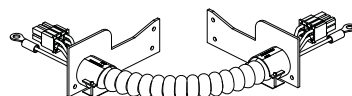

Kit includes:

- Two end plates
- Armored cable assembly
- Mounting hardware

### CERTIFICATIONS



### MORE INFORMATION

For additional specifications, wiring examples, available accessories, and warranty information, please visit [www.i2Systems.com](http://www.i2Systems.com) or contact your i2Systems representative.

**i2Systems®**  
 ADVANCED LED LIGHTING

Integrated Illumination Systems, Inc.  
 355 Bantam Lake Road  
 Morris, CT 06763 USA

tel +1.860.567.0708  
 fax +1.860.567.2501  
 sales@i2Systems.com

Product information is subject to change without notice.  
 All brand names and product names are trademarks of i2Systems.  
 © 2016 i2Systems. All Rights Reserved.

[www.i2Systems.com](http://www.i2Systems.com)

090-50389  
 rev A

# i2Cove Asymmetrical Installation Instructions

## INSTALLATION INSTRUCTIONS

**DANGER: RISK OF ELECTRICAL SHOCK OR FIRE. DISCONNECT POWER BEFORE INSTALLATION.**

Adhere to local electrical codes. If you are not familiar with these codes, consult a qualified electrician.

- 1 Verify the input current and fixture wattage.** There is a label on each fixture which outlines the acceptable input voltage as well as the watts per foot at 50/60 Hz. The input Voltage AC and the wattage of the fixture will determine the fixture run length.



Exceeding the voltage input and acceptable fixture run lengths will result in damage to the lighting fixture and pose a serious safety hazard.

Input	5W Max. Run	8W Max. Run	10W Max. Run	12W Max. Run
120 VAC	100 ft	60 ft	50 ft	40 ft
208VAC	100 ft	100 ft	80 ft	70 ft
240VAC	100 ft	100 ft	100 ft	80 ft
277 VAC	100 ft	100 ft	100 ft	90 ft

### Review the length of fixture(s) and cable(s).

Power entry unit comes with a 12" cable.

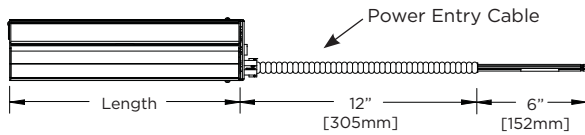

Additional units are supplied with a 6" jumper cable.

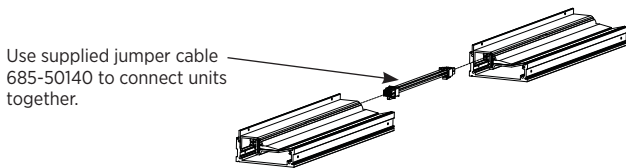

Fixtures can be installed in a variety of configurations: linearly, around corners, or around curved spaces.

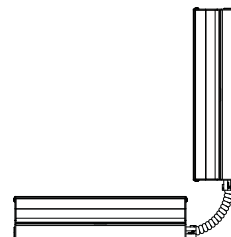
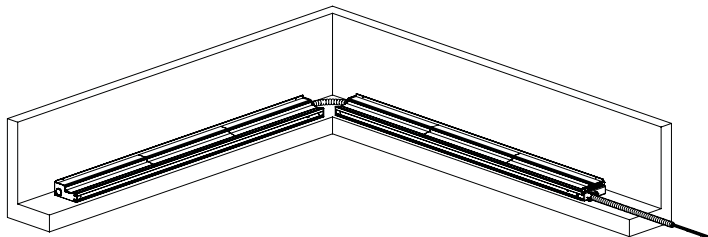

Use Corner Kit CAK-1 for non-linear installations. Refer to Section A on page 4.

Corner Kit cable is 6" long.

# i2Cove Asymmetrical Installation Instructions

## INSTALLATION INSTRUCTIONS (CONT'D)

**DANGER: RISK OF ELECTRICAL SHOCK OR FIRE. DISCONNECT POWER BEFORE INSTALLATION.**

Adhere to local electrical codes. If you are not familiar with these codes, consult a qualified electrician.

- 2** **Install mounting brackets** to the building along the desired path of fixtures. Both fixed and adjustable mounting brackets are available.

Fixed Bracket CAB-1.  
Two brackets are supplied with each fixture.

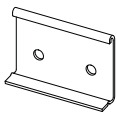

Use two screws per bracket  
(screws not included).  
Two brackets per fixture are recommended.

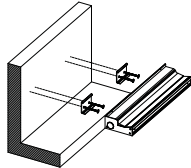

Adjustable Bracket CAB-2 (optional).  
Secure using two screws (not included).

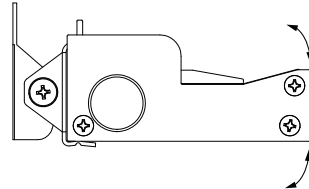

Correctly position the angle of each bracket after snapping in the light.

- 3** **Install lights** in a series, snapping lights into brackets and attaching ground clips between fixtures.

Affix the brackets and snap down lights with the jumper cable attached.  
(Fixed bracket shown)

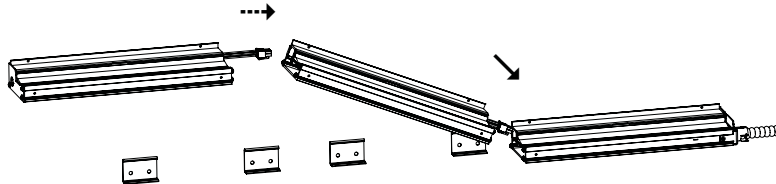

Attach a ground clip provided such that it bridges two lights in series together. Gently tap the clip into place and then attach with a screw (not included).

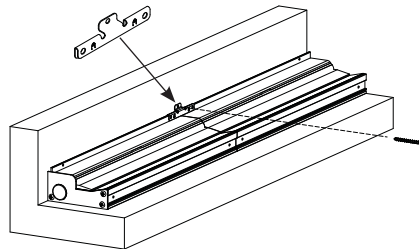

- 4** **Attach the dimming wires** to the 0 - 10 VDC dimming supply. Do not use a higher voltage as this will result in damage to the fixture. If the dimming option is not used, attach wire nuts to cap off wires. The i2Cove has the ability to dim 10% to 100%.

Cut supplied 18" armored cable down (if needed) to reach building power junction box and protect wires on end with protective bushing.

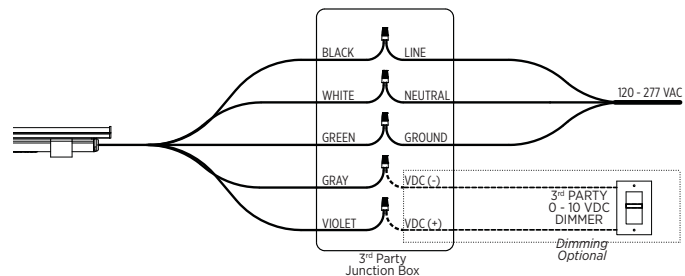
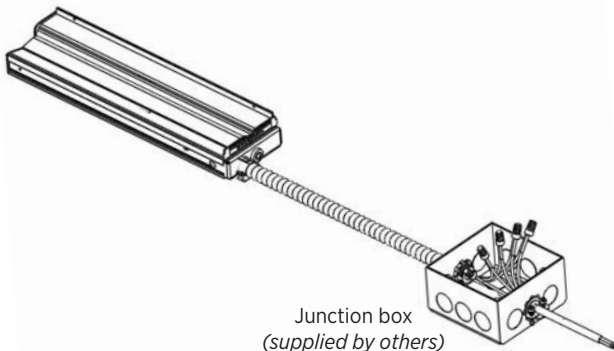

# i2Cove Asymmetrical Installation Instructions

## OPTIONAL COMPONENTS

**DANGER: RISK OF ELECTRICAL SHOCK OR FIRE. DISCONNECT POWER BEFORE INSTALLATION.**

Adhere to local electrical codes. If you are not familiar with these codes, consult a qualified electrician.

**A** Install the **Corner Kit** if you wish to go around a corner. Match the right and left plates with the light.

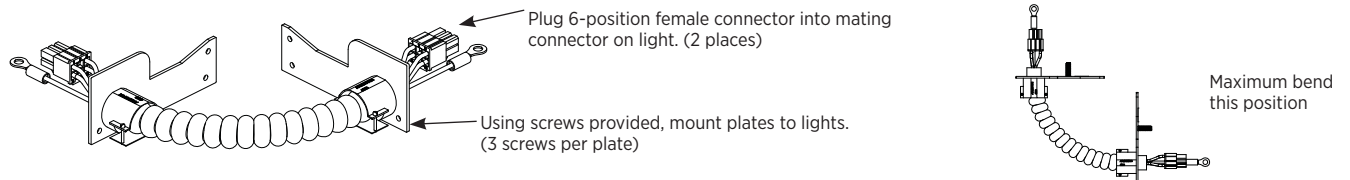

**B** **Move Power Entry** to other end of the light (optional). The power entry box and cable are supplied on the right side of the unit, but can be moved to the left.

If you choose to **keep it on the right side** (as shipped), attach the Left End Plate and insert Hole Plug provided:

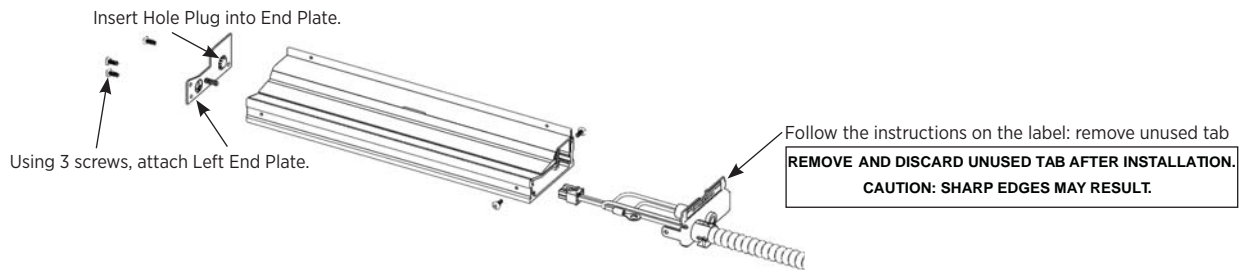

If you choose to **move Power Entry to the left side**, first, remove it from right side:

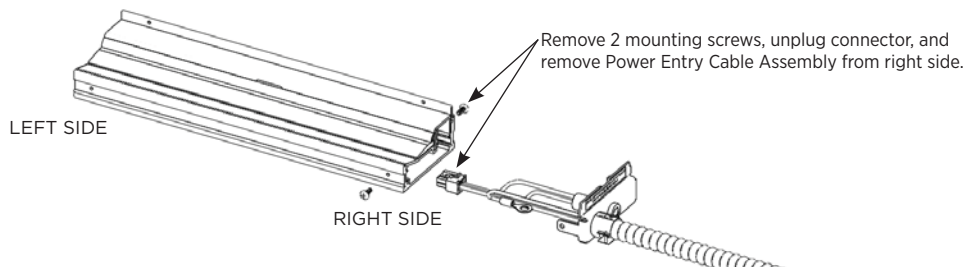

Then, install Power Entry on left side:

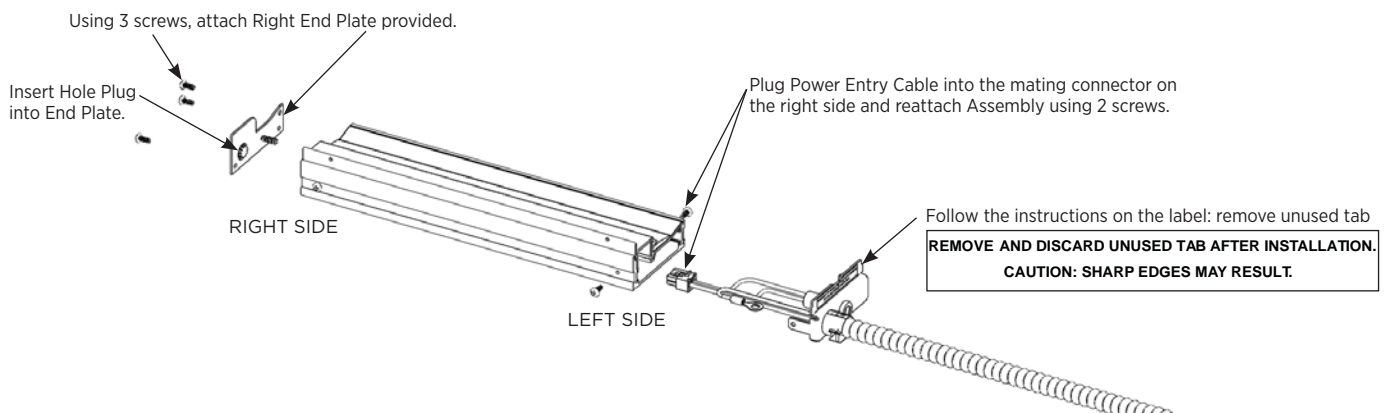

# i2Cove Asymmetrical Installation Instructions

## **DANGER: RISK OF ELECTRICAL SHOCK OR FIRE. DISCONNECT POWER BEFORE INSTALLATION.**

Read and understand the installation instructions before attempting to install or use the fixture. It is the responsibility of the contractor, installer, purchaser, owner and user to install, maintain, and operate i2Cove fixtures in such a manner as to comply with all applicable codes, state and local laws, ordinances, and regulations. Consult with the appropriate electrical inspector to ensure compliance.

### **ELECTRICAL WARNINGS AND CAUTIONS**

- **DANGER:** RISK OF ELECTRICAL SHOCK OR FIRE. DISCONNECT POWER BEFORE INSTALLATION.
- **WARNING:** Do not use a fixture for any voltage for which it is not rated. Do not exceed the specified voltage and current input for any fixture. Each unit contains a label outlining the fixture wattage. The label also contains the part number, date manufactured, and individual serial number assigned to the fixture.



Model/Part Number

Serial Number

- **WARNING:** Ensure that main power supply is off before installing or wiring a fixture.
- **WARNING:** Risk of fire or electric shock, installation requires knowledge of luminaire electrical systems. Luminaires must be installed by a qualified electrician according to local and national codes for proper installation.
- **WARNING:** Risk of fire or electric shock. Luminaire wiring and electrical parts may be damaged when drilling.
- **WARNING:** To prevent wiring damage or abrasion, do not expose wiring to edges of sheet metal or other sharp objects.
- Only use fixtures with voltage for which it is rated. Do not exceed the specified input voltage and current.
- Fixtures have line voltage risk of shock and no user serviceable parts. Do not attempt to open.
- Do not use a fixture if the lens, housing, or power cables are damaged.
- Do not hot swap fixtures. Ensure that power to the series is off before connecting or disconnecting individual fixtures.
- Contractor is responsible for adequately reinforcing walls and/or ceilings to support luminaire weight. i2Systems accepts no responsibility for inadequately reinforced walls and/or ceilings.
- Do not make or alter any open holes in an enclosure of wiring or electrical components during installation.
- Wear proper safety equipment and follow appropriate safety precautions.
- Connect to a properly grounded branch circuit protected by a circuit breaker or fuse.
- Always use i2Systems and/or i2Systems-recommended electrical components.
- For use on systems with voltages greater than the maximum rated voltage, use a safety agency approved, step-down power supply to convert the higher voltage to a voltage within the specified operating range of the fixture.

### **WARRANTY AND MAINTENANCE**

The linear lighting that you have purchased is a self-contained system; do not attempt to repair or disassemble the light.

There is no recommended maintenance for this product.

For a copy of our limited warranty please visit [www.i2Systems.com](http://www.i2Systems.com).

### **INSTALLATION / THERMALS**

- Once installed, monitor the fixture case temperature. The fixture case temperature should not exceed 50°C at worst case ambient. Should the case temperature exceed the max rating of 50°C, do one or more of the following: reduce the ambient temperature, heatsink the fixture, increase the airflow or volume of air around the fixture, or remove the fixture and install a lower power fixture.
- Do not install the light fixture where any liquid will come in contact with the luminaire or the wiring. Do not install the light fixture where it will sit in any liquid or where liquid will collect, pool or puddle. Fixture is suitable for indoor dry locations only.
- It is recommended that the light fixture remain in its original container until it is ready to be installed.

### **FCC NOTICE**

The hardware device complies with Part 15 of the FCC Rules. Operation is subject to the following two conditions:

1. This device may not cause harmful interference, and
2. This device must accept any interference received, including interference that may cause undesired operation.

This equipment has been tested and found to comply with the limits for a Class A device, pursuant to Part 15 of the FCC regulations. These limits are designed to provide reasonable protection against harmful interference in a residential or commercial installation. However there is no guarantee that interference will not occur in a particular installation. This equipment generates, uses, and can radiate radio frequency energy and, if not installed or used in accordance with the instructions, may cause harmful interference to radio communications. If this equipment does cause harmful interference to radio or television reception, which can be determined by turning the equipment off and on, the user is encouraged to try to correct the interference by one or more of the following measures:

1. Reorient or relocate the receiving antennae;
2. Increase the separation between the equipment and the receiver;
3. Connect the equipment to an outlet on a circuit different from that to which the receiver is connected;
4. Consult the dealer or an experienced radio/TV technician for help.

Any changes or modifications not expressly approved by the party responsible for compliance could void the user's authority to operate the equipment. Where shielded interface cables have been provided with the product or specified accessories elsewhere defined to be used with the installation of the product, they must be used in order to ensure compliance with FCC regulations.